

# Door Stop Seals

# Sealmaster®

## SEALMASTER MONSOON

For heavy duty door applications, roller shutter doors & sliding doors

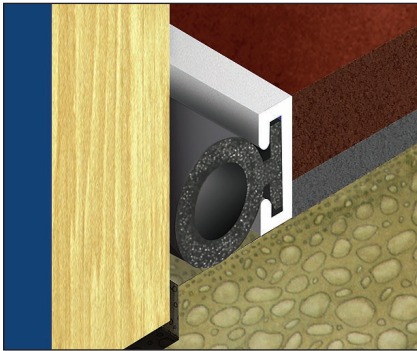

SHS/027

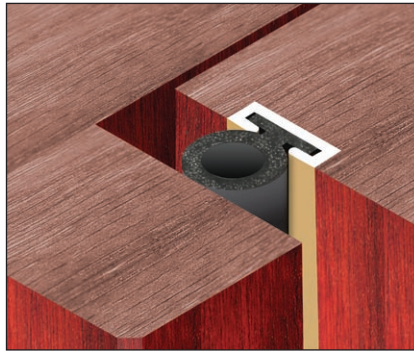

SHG/026

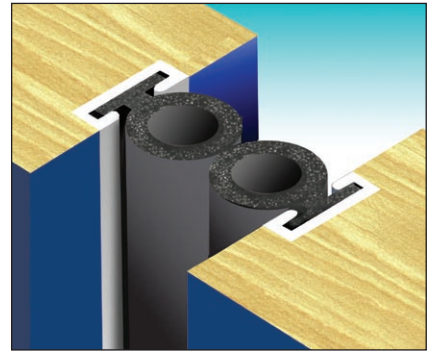

SHS/026

### APPLICATIONS

A heavy duty draught and noise seal for industrial or other large applications.

### FEATURES & BENEFITS





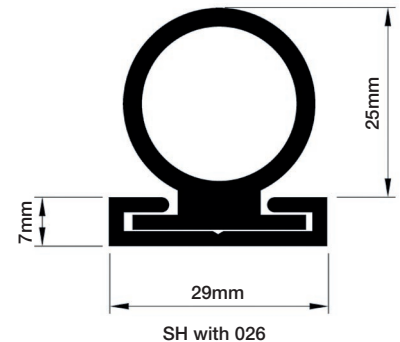
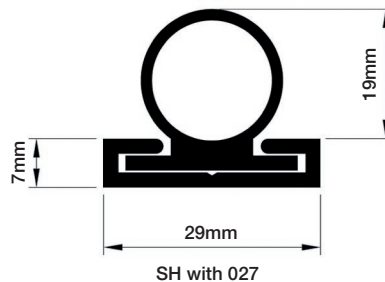
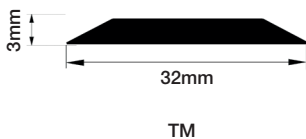

Monsoon seals are circular heavy duty draught and noise seals, particularly suitable for use in industrial applications on large doors where the gaps are consistent and for the bottom of roller shutter doors.

On roller shutter doors, these seals should make contact with a suitable threshold, such as the Thunder TMS or TMG.

### HOW TO SPECIFY

e.g. Sealmaster Monsoon SHS/026 with Sealmaster Thunder TMS contact strip to suit door in .....mm wide opening.



| Standard Options   | Insert 026   | Insert 027   | NONE |
|--|--|--|------|
| Satin Silver - SHS  | <br>SHS/026 | <br>SHS/027 |      |
| Satin Gold - SHG    | SHG/026  | SHG/027  |      |
| Satin Silver - TMS  |  |  | TMS  |
| Satin Gold - TMG    |  |  | TMG  |